

SPICE thermal model

BUK9Y38-100E

Symbol	Parameter	Conditions	Min	Typ	Max	Unit
$R_{th(j-mb)}$	thermal resistance from junction to mounting base		-	-	1.58	K/W

C_{th1}	2.916E-05 F
C_{th2}	1.726E-04 F
C_{th3}	2.092E-04 F
C_{th4}	1.786E-03 F
C_{th5}	2.130E-03 F
C_{th6}	8.451E-03 F
C_{th7}	8.634E-02 F
R_{th1}	2.749E-03 Ω
R_{th2}	5.716E-03 Ω
R_{th3}	4.154E-02 Ω
R_{th4}	5.616E-02 Ω
R_{th5}	3.287E-01 Ω
R_{th6}	1.016E+00 Ω
R_{th7}	1.301E-01 Ω

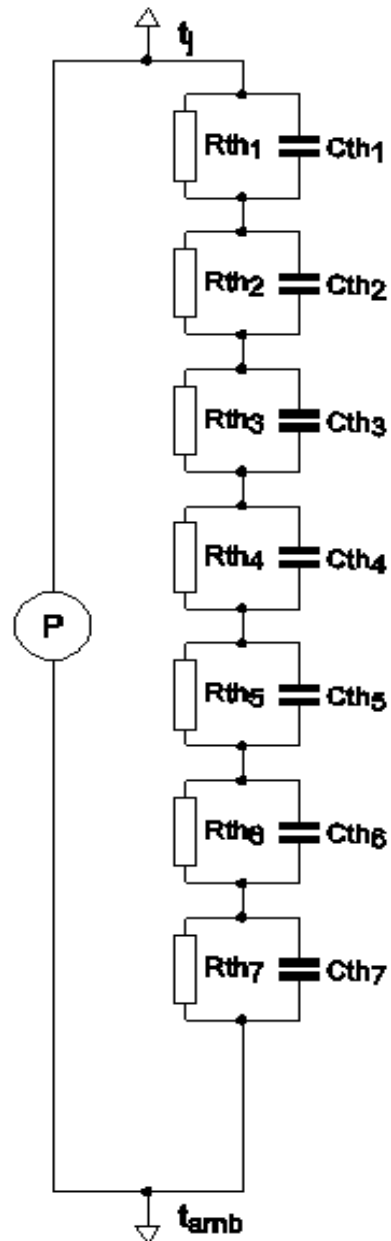

Part: BUK9Y38-100E
 Date: 25/1/2013
 Rth 1.58 K/W